

TEMP-PLATE® IDEA BOOK

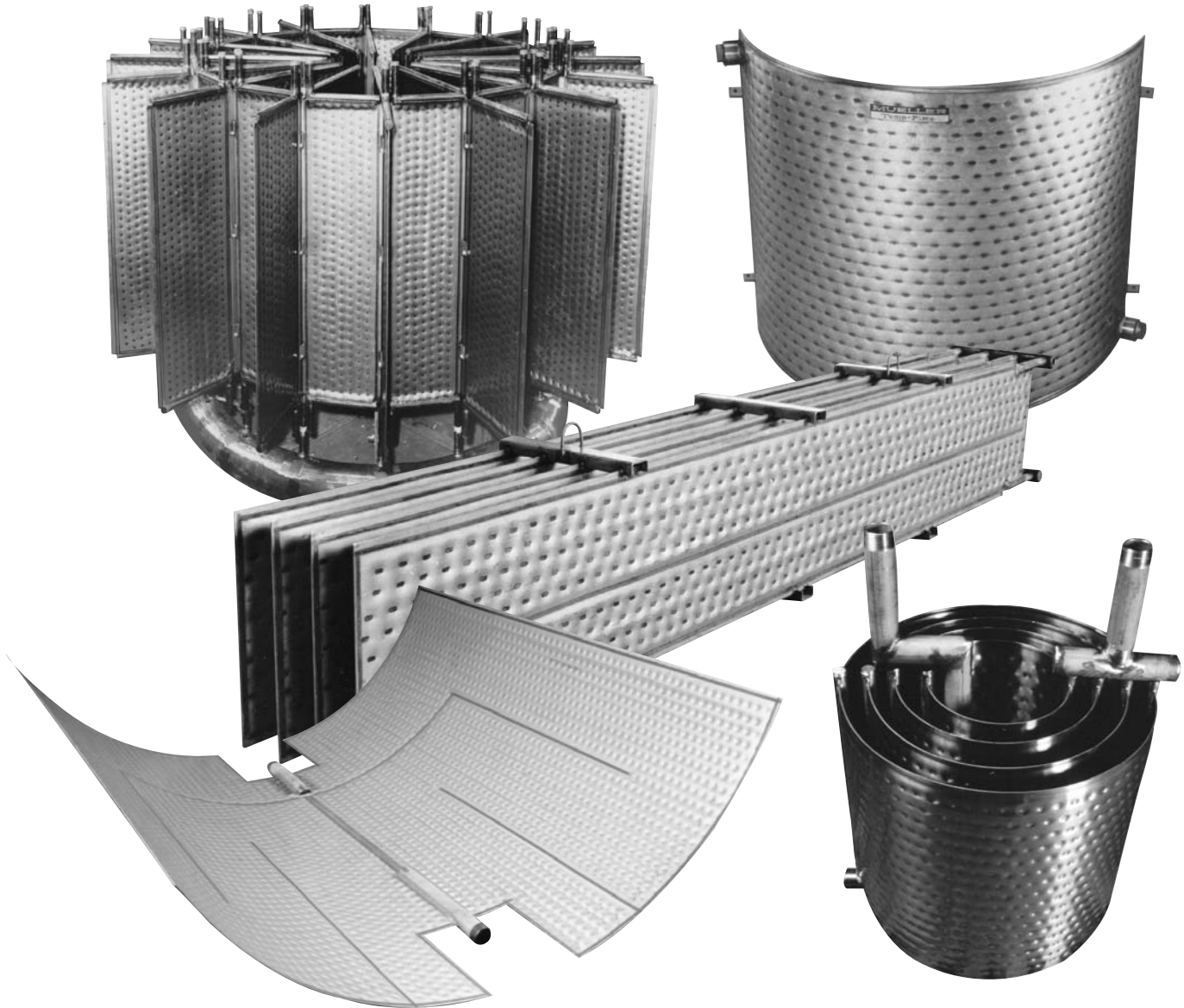

THE WORLD OF MUELLER® TEMP-PLATE...

Mueller Temp-Plate is an extremely versatile heat transfer product and can be supplied in an almost unlimited number of styles, shapes, and materials.

This booklet is intended to give the design engineer a glimpse of its many applications. Some of the items are our standard cataloged products; however, most of these applications were developed for our customers to meet their particular needs.

MUELLER®
HEAT TRANSFER PRODUCTS

IMMERSION SECTIONS

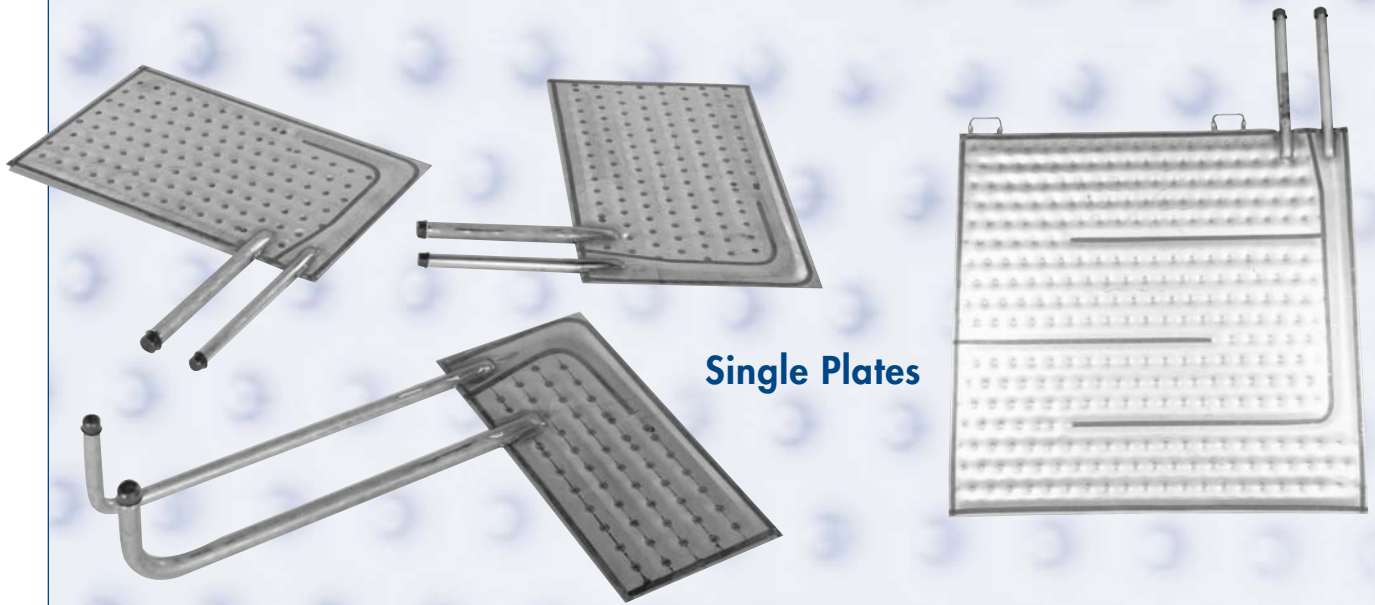

Single Plates

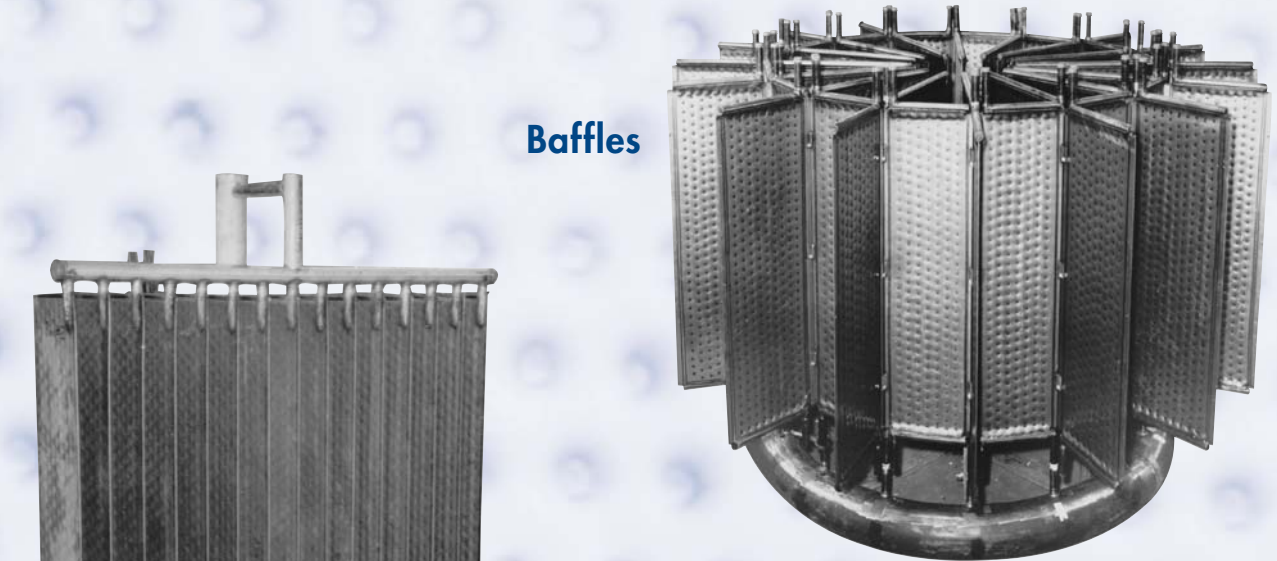

Baffles

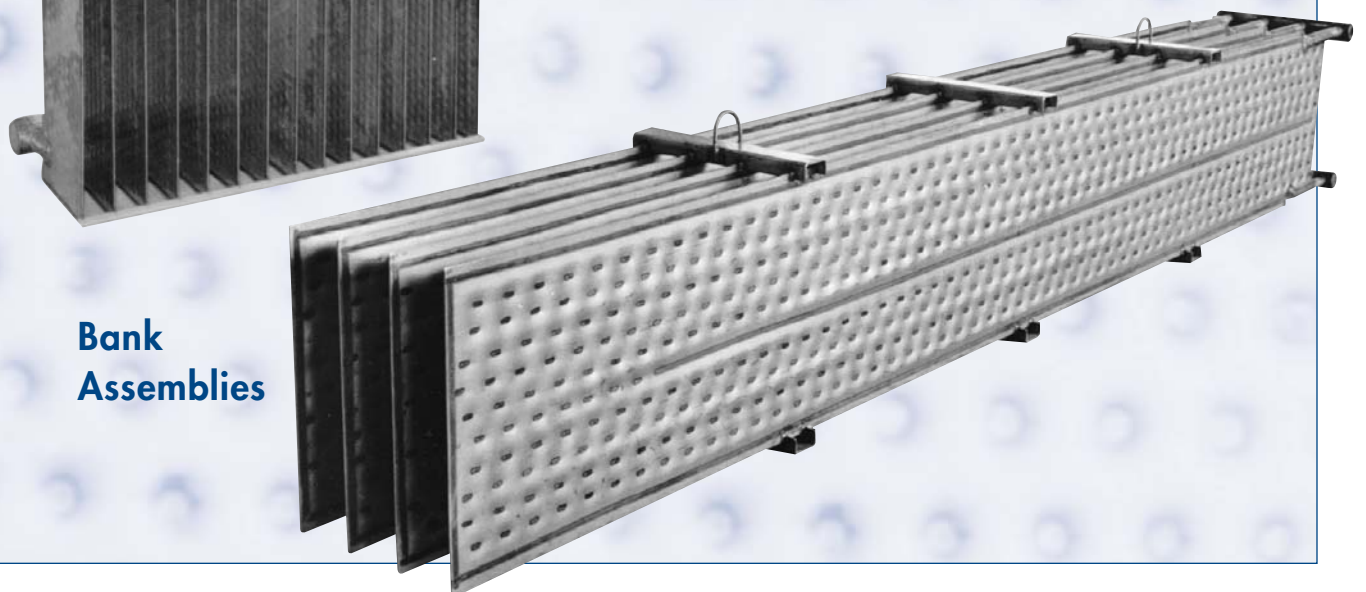

Bank Assemblies

CLAMP-ON SECTIONS

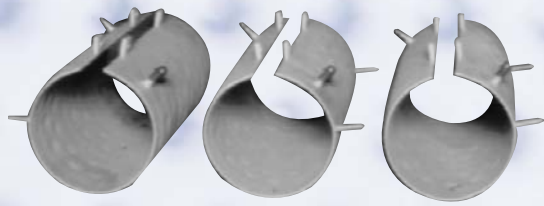

Pipe Clamp-Ons

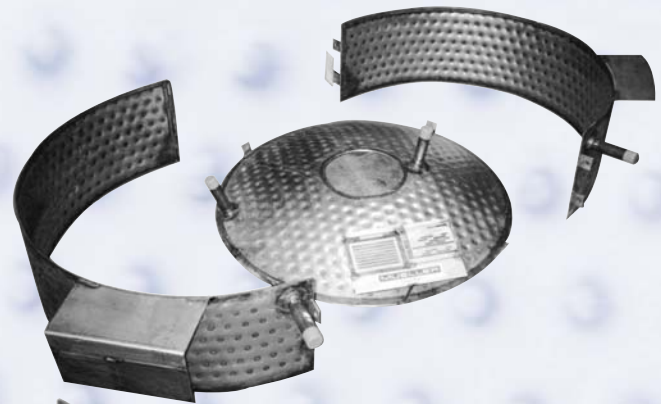

Clamp-Ons

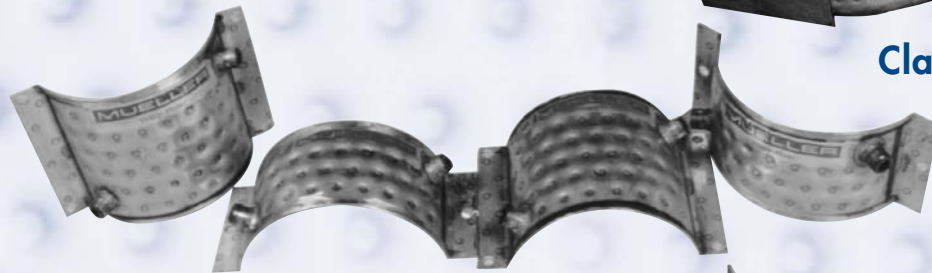

Shell Clamp-Ons

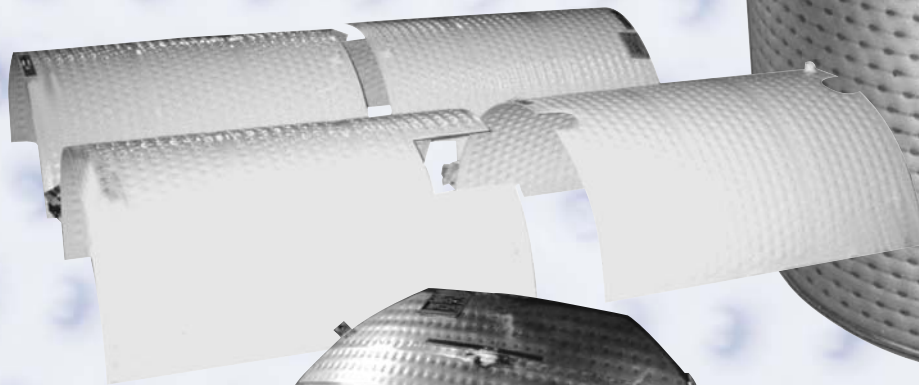

Head Clamp-On



Cone Heads

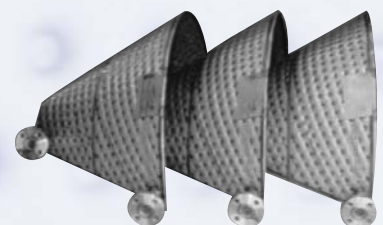

SPECIAL APPLICATIONS

Calandria

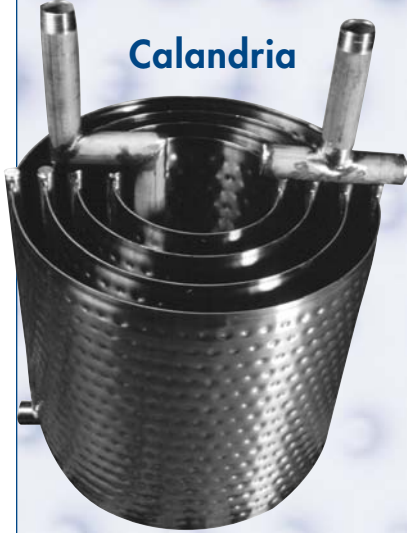

Insertion Heaters

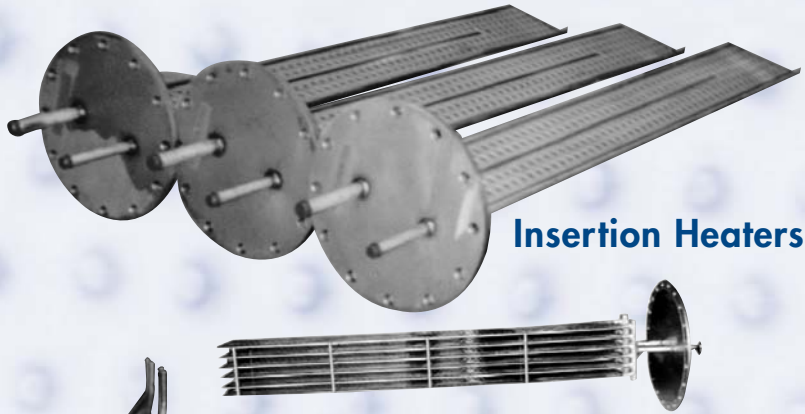

Cooling Shrouds

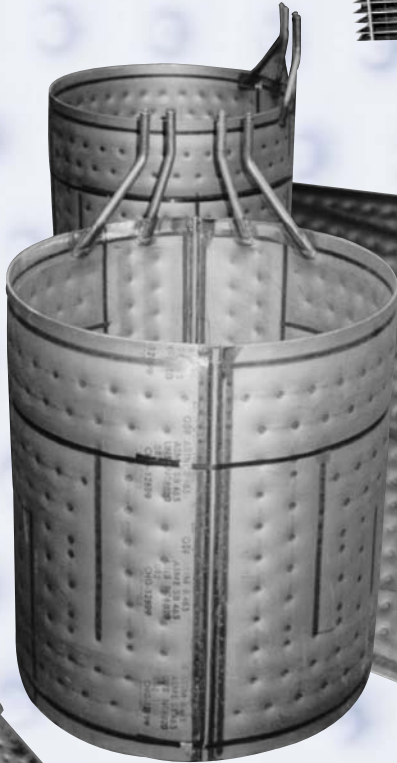

Hopper

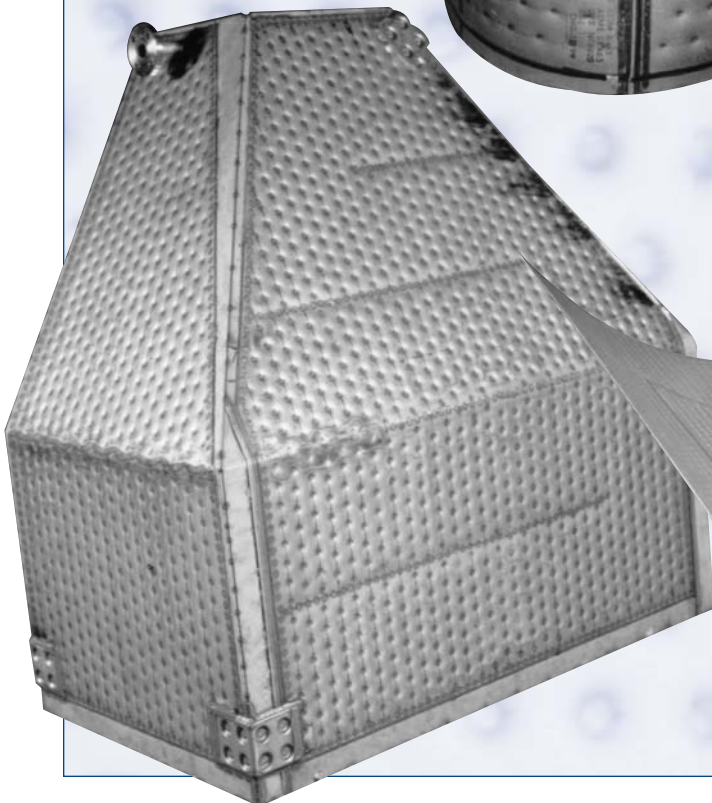

Flat Clamp-Ons

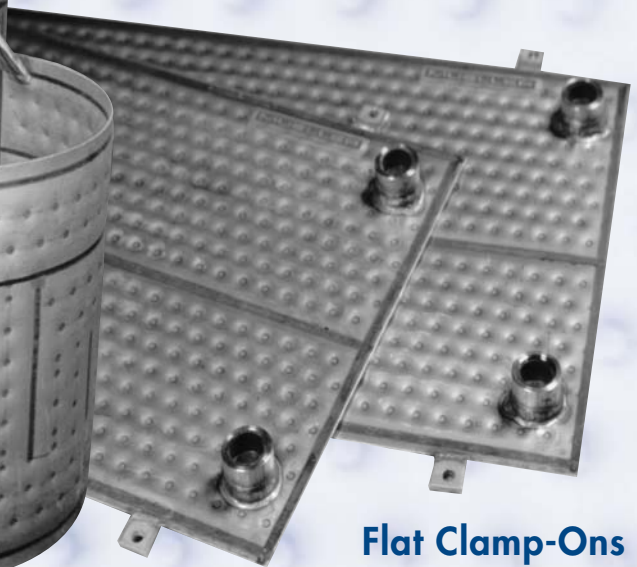

Dye Beck Heater

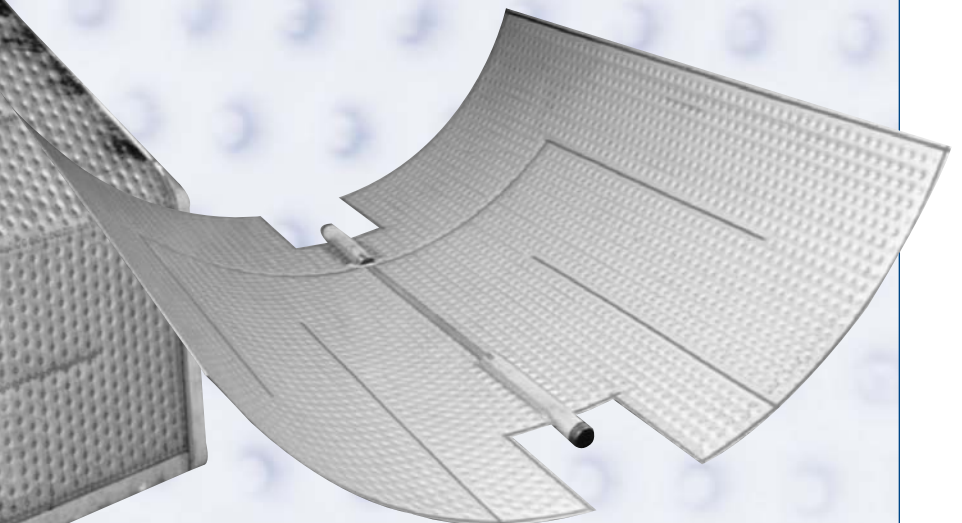

SPECIAL APPLICATIONS

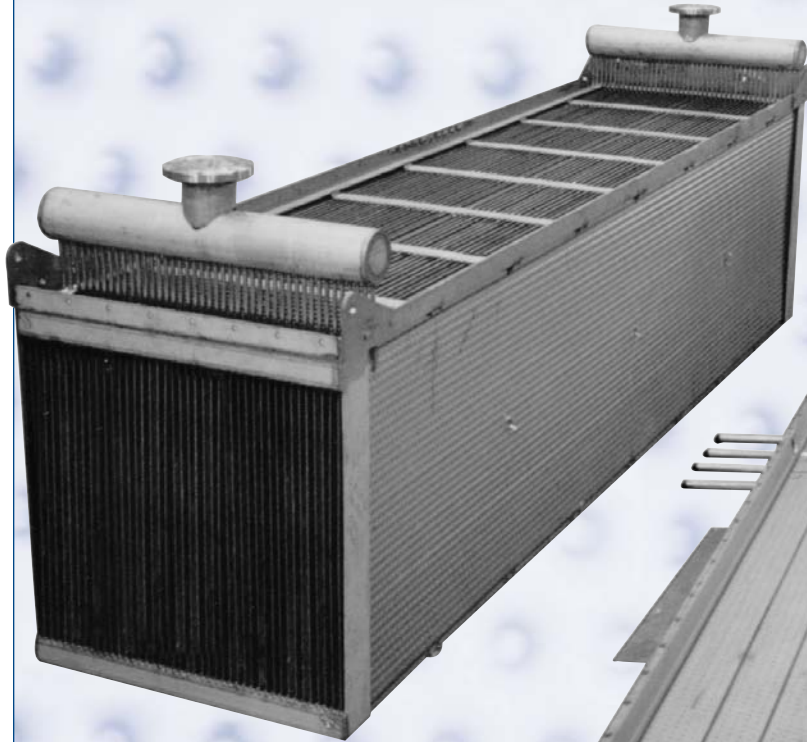

Heat Recovery
Bank Assembly

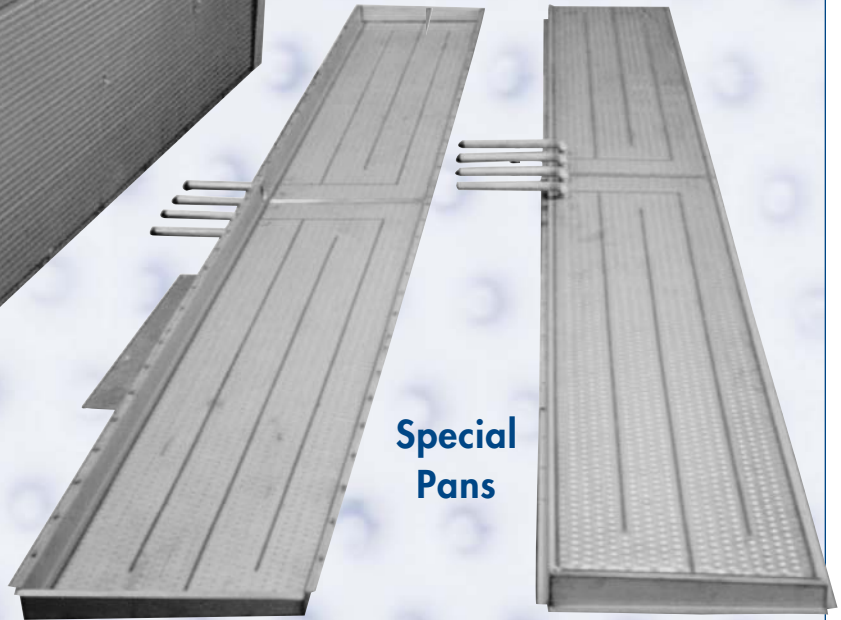

Special
Pans

Food
Cooker

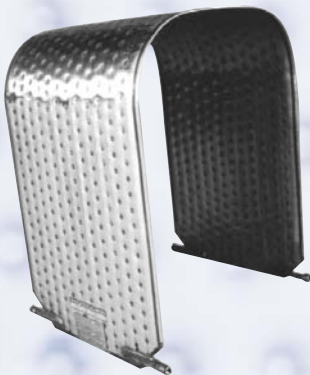
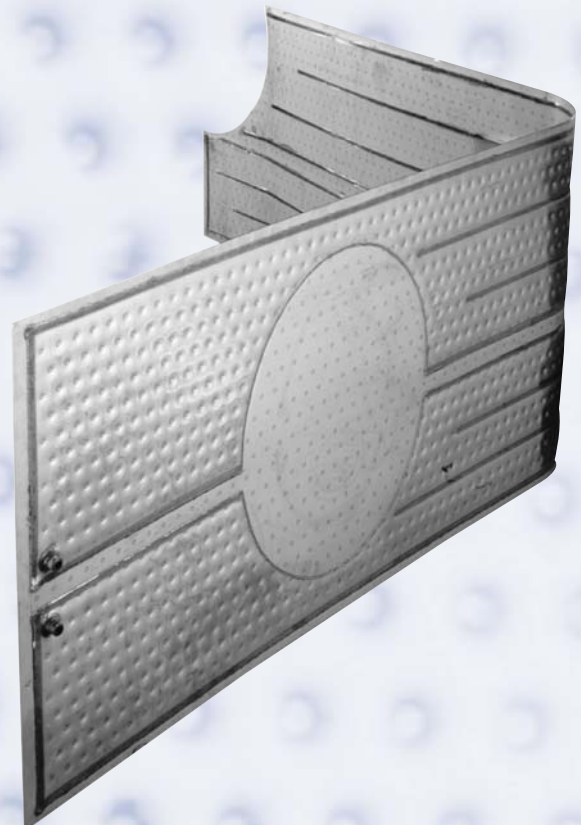
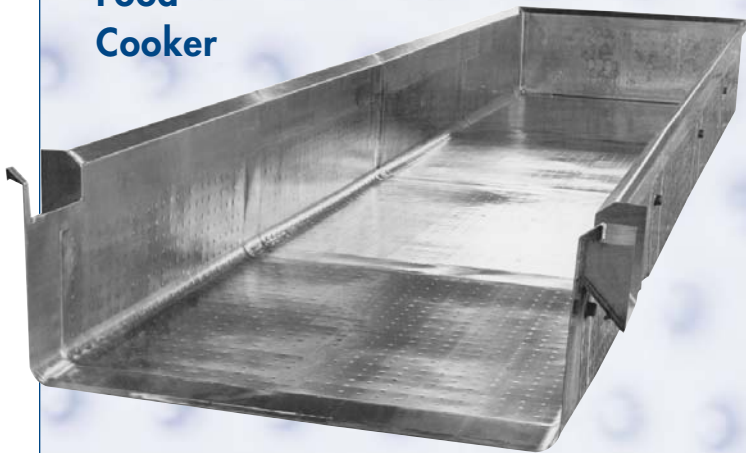

Heat Shields

SPECIAL INTEGRAL AND OEM SECTIONS



Jacketed Shell and Head Assembly

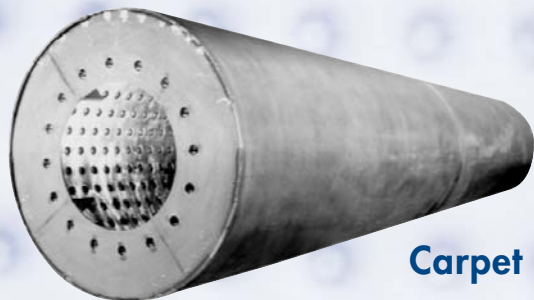

Carpet Drum

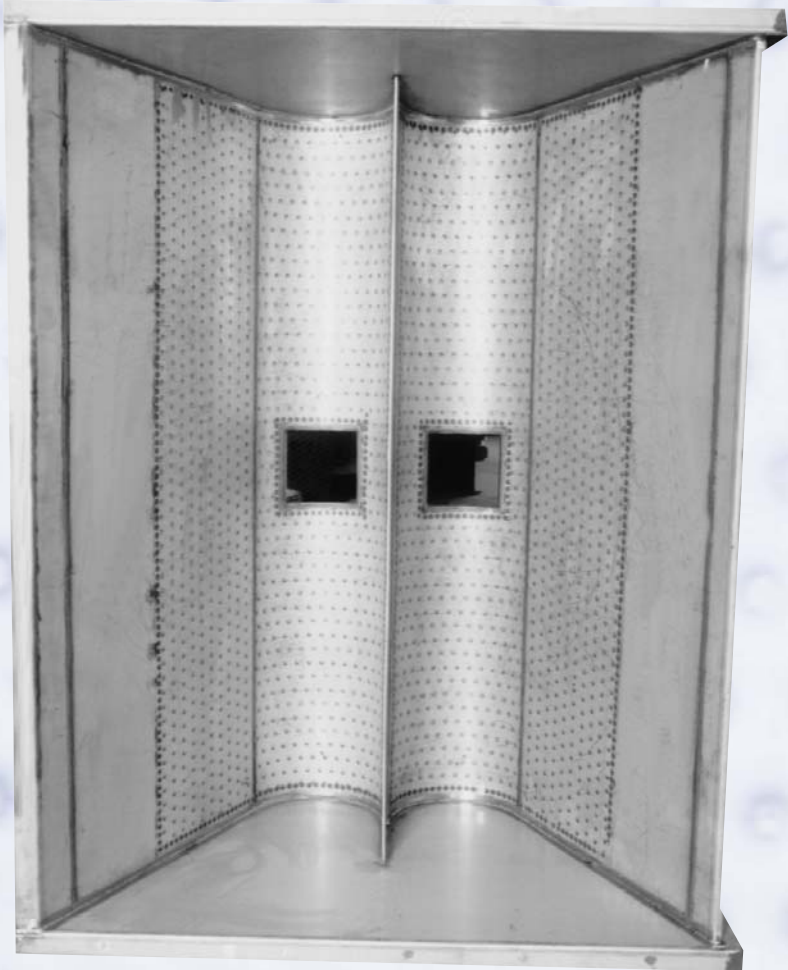

Jacketed "W" Trough



Shell Clamp-On Section

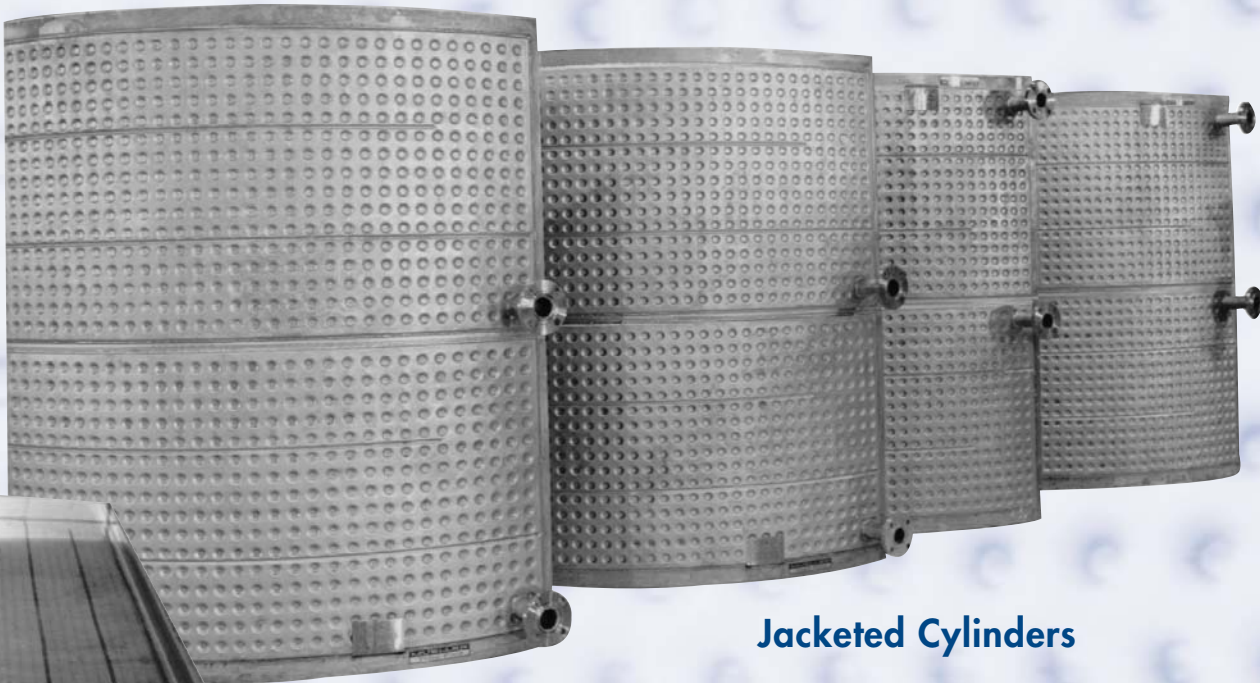

Jacketed Cylinders



Food Service Frost Pan

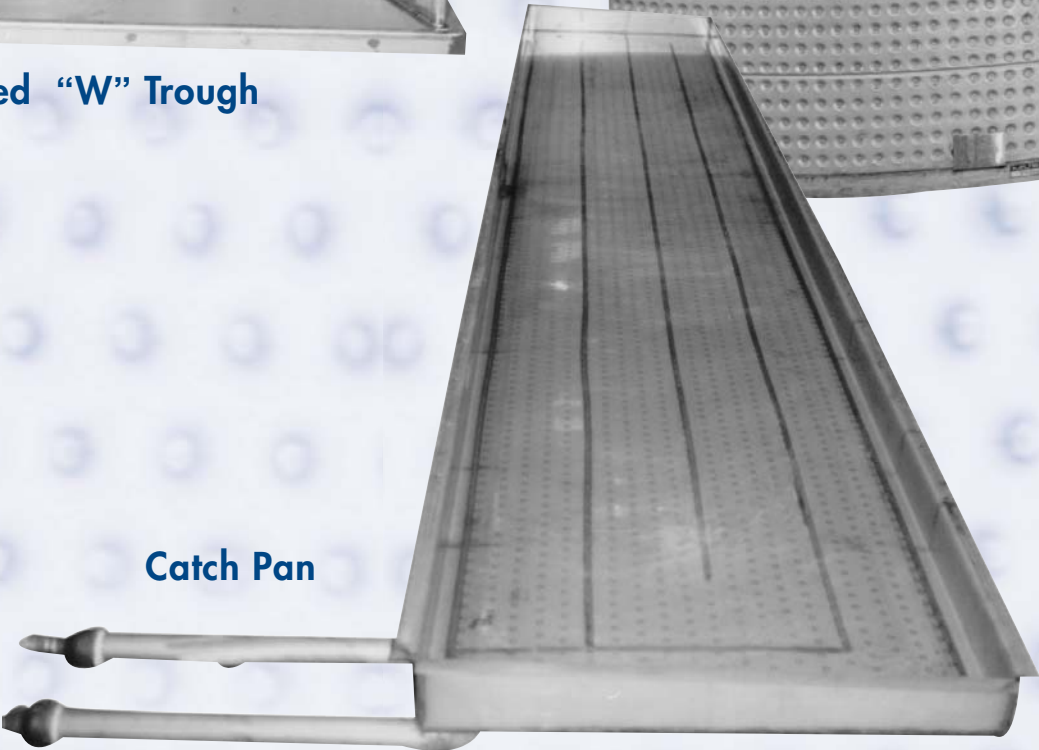

Catch Pan



Jacketed Trough

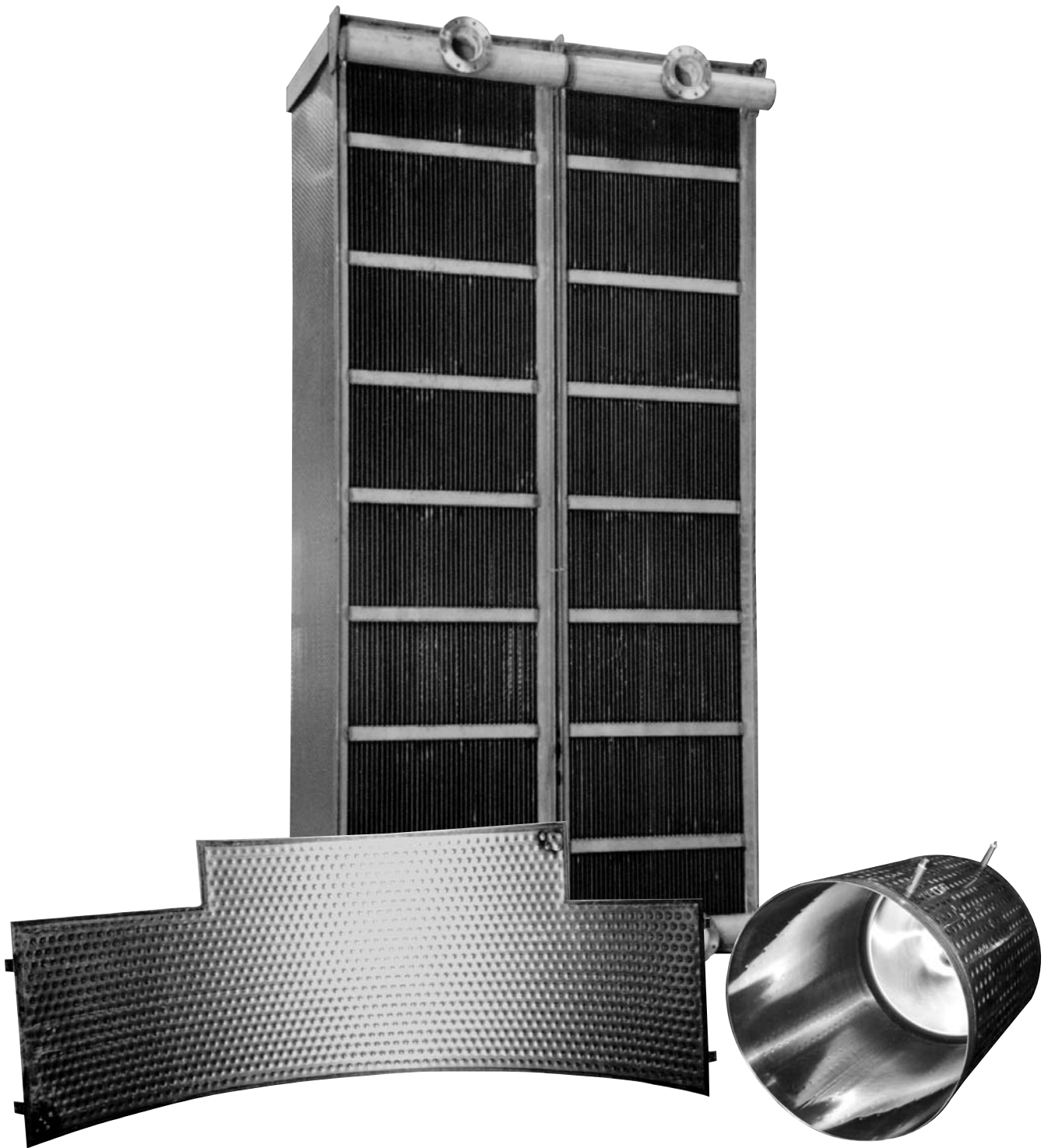

MUELLER®

P.O. Box 828 • Springfield, Missouri 65801-0828, U.S.A.

Phone: (417) 831-3000 • 1-800-MUELLER • Fax: (417) 575-9885 • www.muel.com • E-mail: heattrans@muel.com

International Inquiries - Fax: (417) 831-6906

©1997-2002 Paul Mueller Company



TP-107-2